

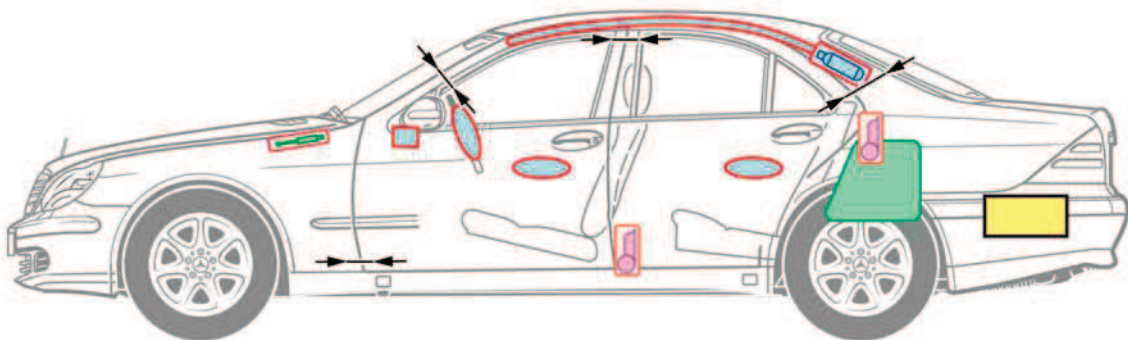

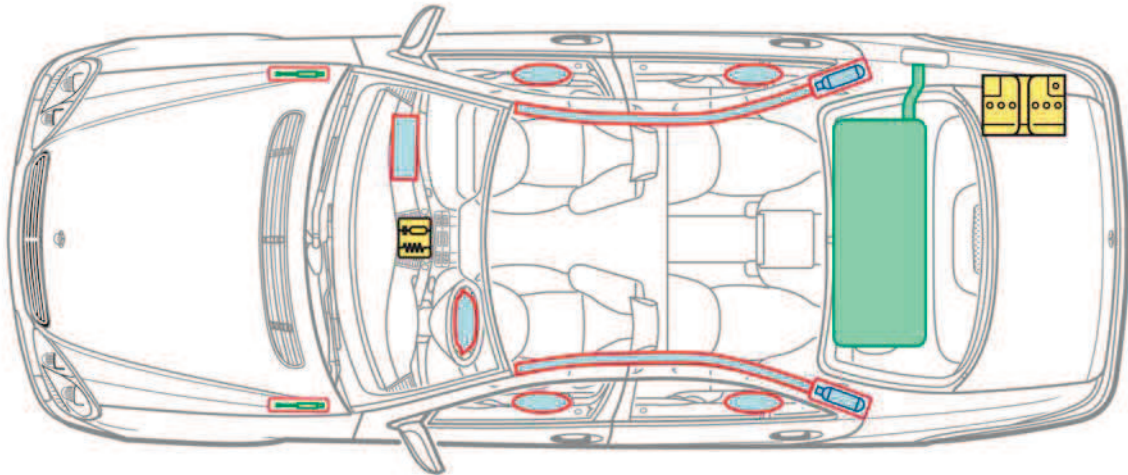

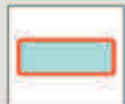



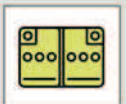
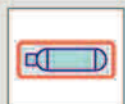

**Classe S  
Berline  
Type 220**

1998-2005

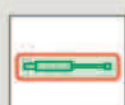

Légende

	Airbag		Renfort de carrosserie		Batterie
	Générateur de gaz		Arceau de sécurité		Composants haute tension
	Rétracteur de ceinture		Réservoir de carburant		Points de coupe
	Amortisseur à gaz		Calculateur		