

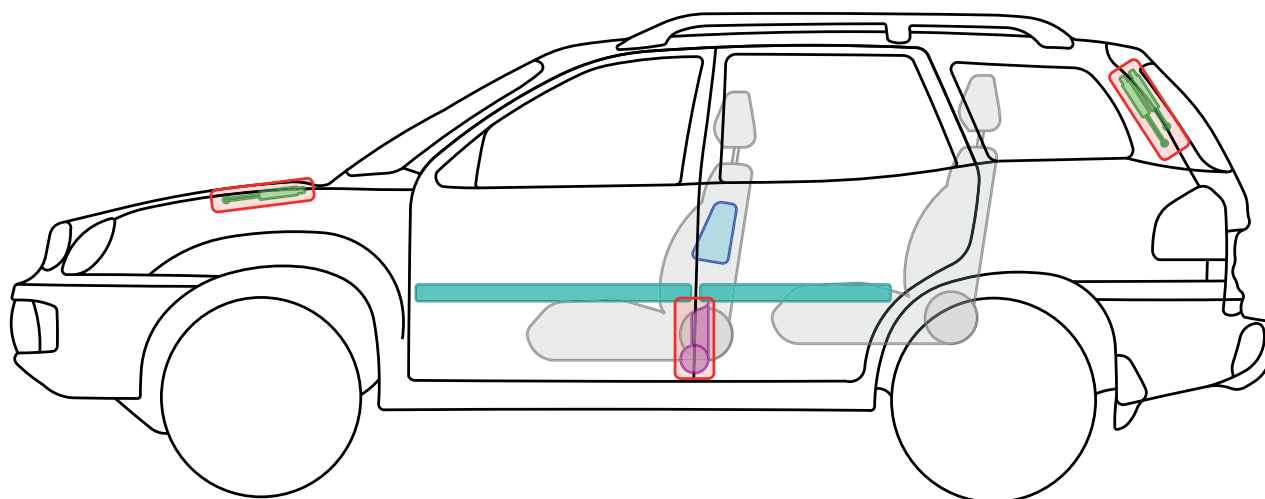

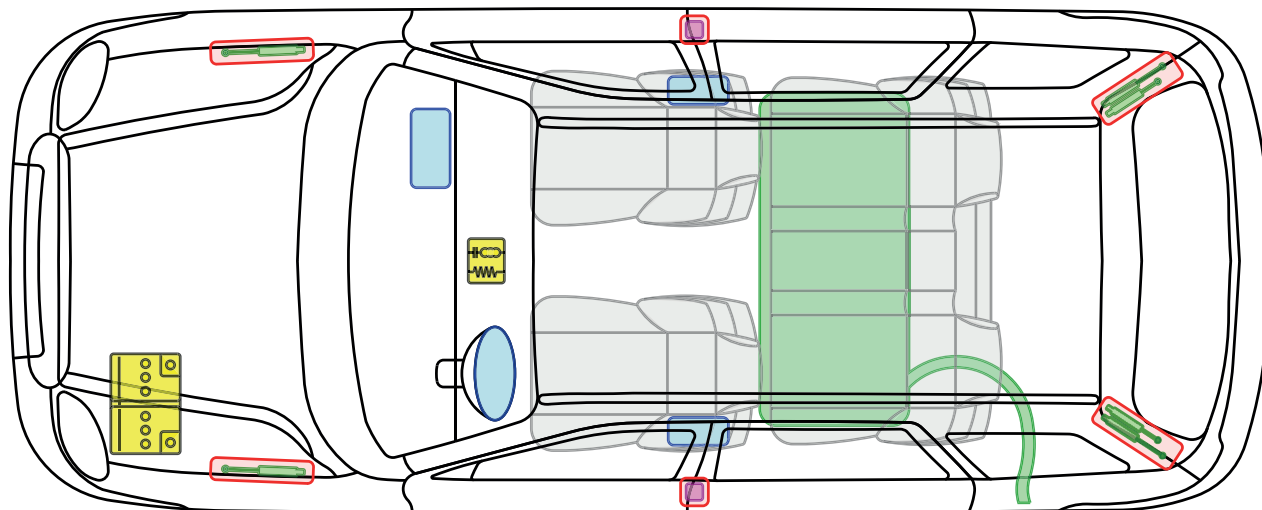



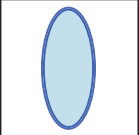

Santa Fe, 5-Türer

(Typ SM, 2000-2006)

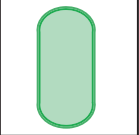
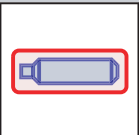
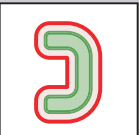
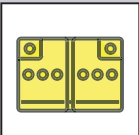

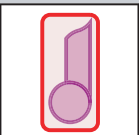
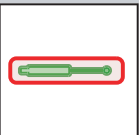
Legende

	Airbag		Karosserie- verstärkung		Steuergerät		Gastank
	Gas- generator		Überroll- schutz		12 V Batterie		Sicherheits- ventil
	Gurt- straffer		Gasdruck- dämpfer		Kraftstoff- tank		

Santa Fe