

Malibu

4-portes







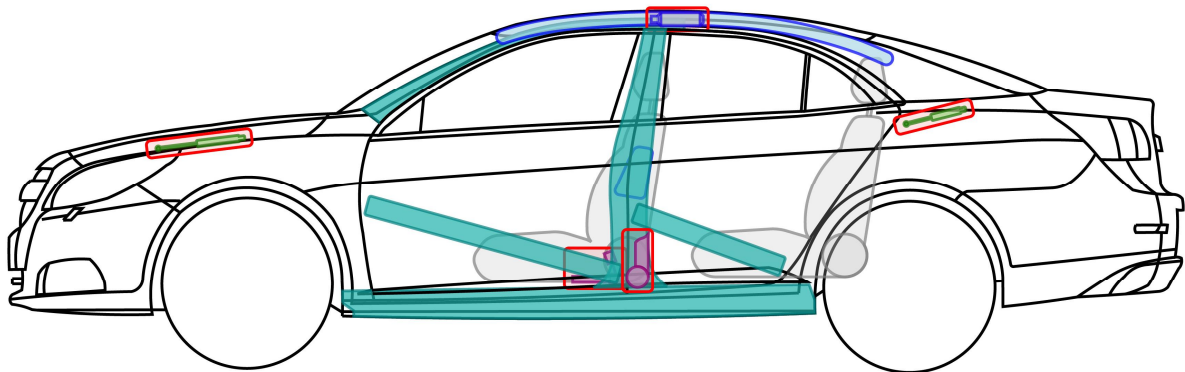
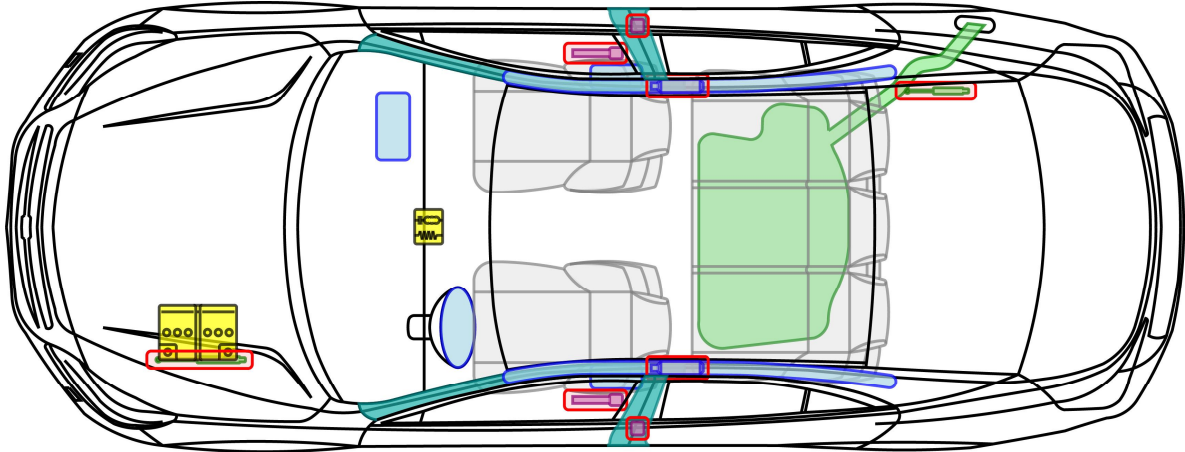

Année de construction 2011 →

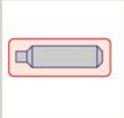

CHEVROLET

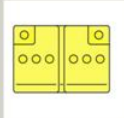

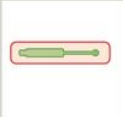
Légende

	Airbag		Renfort de carrosserie		Module de commande
	Générateur de gaz		Protection anti-écrasement		Batterie
	Tendeur de ceinture		Amortisseur pneumatique		Réservoir à carburant

Malibu