

2007 Saturn AURA Green Line Hybrid

2008 Chevrolet Malibu Hybrid

Emergency
Response
Guide



This guide specifically addresses the Saturn AURA Green Line and Chevrolet Malibu Hybrid vehicles.

While a majority of the systems installed on these hybrids are common to traditional GM vehicles, a number of components are different and may affect how a rescue procedure is performed.

We will note those differences as well as highlight ways to easily identify our hybrids from their non-hybrid counterparts.

Finally, we will illustrate where the cut zones are to help you safely extricate occupants from the vehicle.



System Operation

The Saturn AURA Green Line and Chevrolet Malibu Hybrid are gasoline-electric vehicles that use a 36 volt electrical system and traditional 12 volt battery to achieve significant fuel economy improvements.

Both vehicles are equipped with a 2.4 liter, 4-cylinder engine and a traditional 12 volt starter motor, which is used only for initial starts of the vehicle.



2.4 L Engine

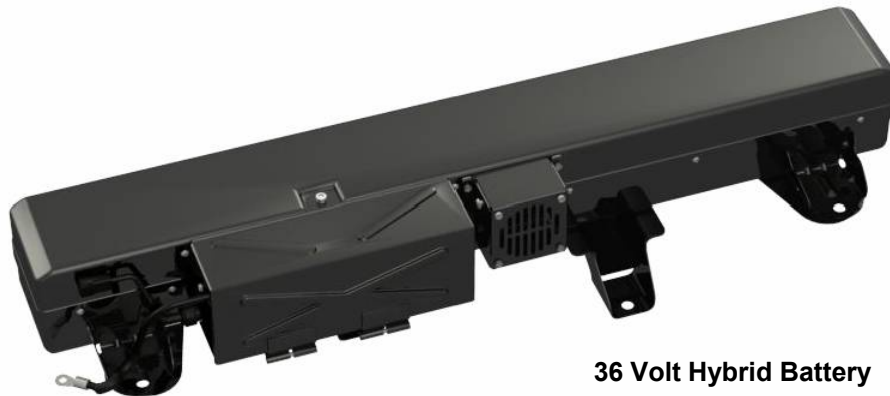

36 Volt Hybrid Battery

System Operation (cont.)

During braking and deceleration, energy is recovered and stored in the hybrid battery (also known as the generator battery). The engine's fuel supply is interrupted and the engine temporarily shuts off as the vehicle comes to a full stop. This is referred to as Auto Stop.

There are conditions when the engine will be restarted by a special starter generator. Some of these conditions include:

- The gear shift lever is moved from Drive to another gear
- The hybrid battery charge is low and requires recharging
- Auto Stop has timed out (maximum of 120 seconds)
- Normal A/C mode is selected
- Full front Defrost mode is selected
- The accelerator pedal is applied
- The brake pedal is released

NOTE: The starter generator cannot provide sustained vehicle propulsion by itself. It is primarily used for starting the engine after an autostop and for engine assist during accelerations.



System Operation (cont.)

Several factors affect how long the engine remains off during Auto Stop. Some of these factors are:

- Air Conditioning setting (A/C is affected by outside temperature when Hybrid A/C light is illuminated)
- Hybrid Battery state of charge is low
- Time limit (maximum of 120 seconds)

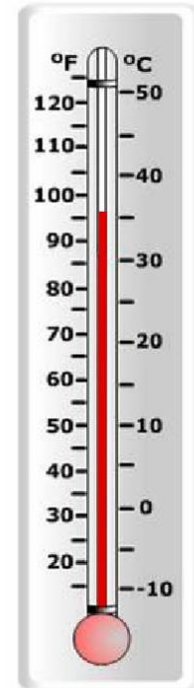

Hybrid
A/C Button



System Operation (cont.)

There are many circumstances that the engine will not enter Auto Stop. Some of these conditions are:

- Engine is not warmed up
- Shift lever is in any gear except Drive
- Hybrid battery state of charge is low
- 12v vehicle battery charge is low, or charge requirements are high
- Hood is not fully closed
- Full front Defrost mode
- Blower speed on high
- A/C in normal



Vehicle Identification

Special badging is attached to the trunk lid.

*Note: Saturn AURA Green Line shown,
Chevrolet Malibu Hybrid similar.*

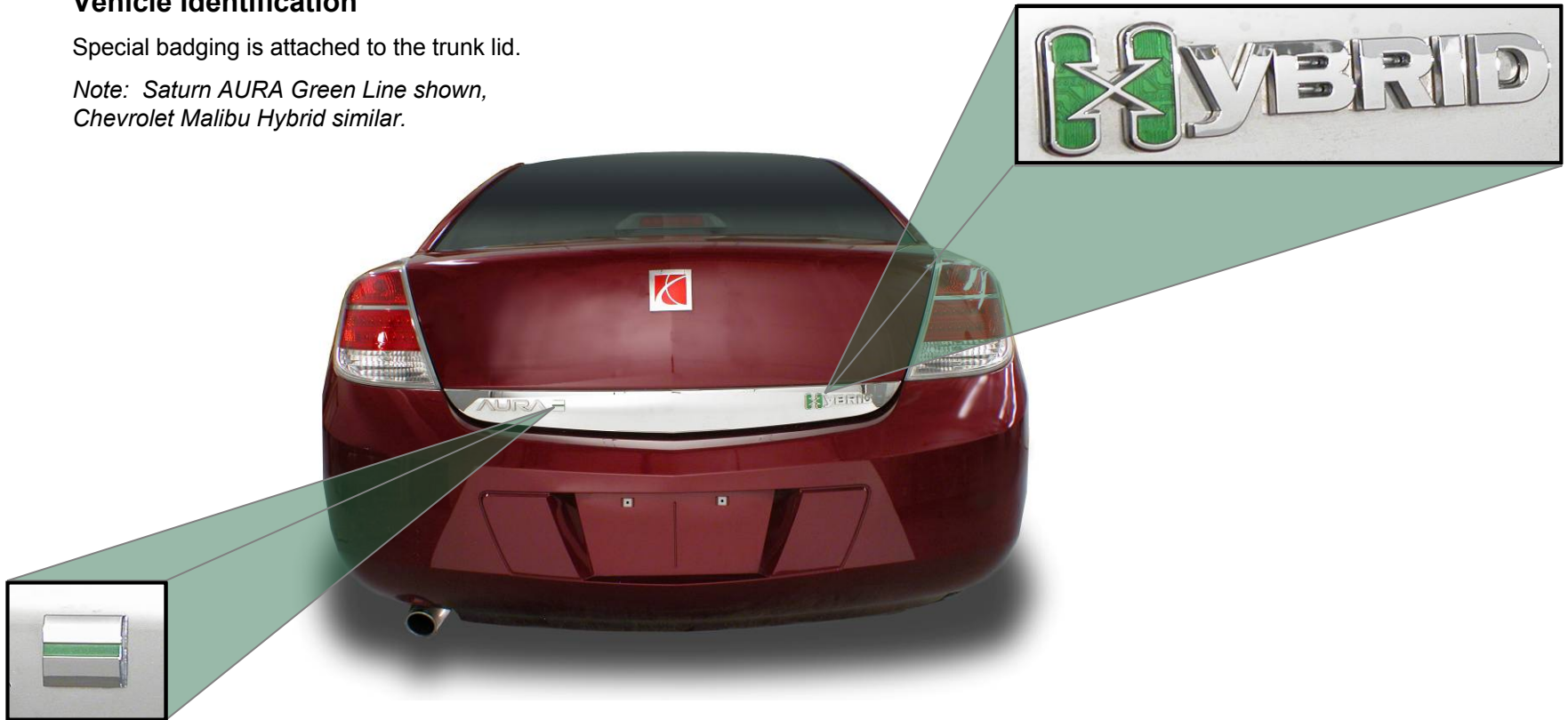

NOTE: Green Line
emblem only on
Saturn AURA

Vehicle Identification (cont.)

A hybrid badge is attached to the driver and passenger front doors.

Note: Saturn AURA Green Line shown, Chevrolet Malibu Hybrid similar.



Vehicle Identification (cont.)

A tachometer with Auto Stop indicator and a Charge/Assist gauge are part of the instrument panel cluster.





Charge/Assist Gauge



Tachometer with Auto Stop Indicator



⚠ CAUTION	36V	⚠ ATTENTION	36V	
Two Battery Locations To help avoid personal injury during 36V hybrid system service, disconnect  both locations. See diagram.			Emplacements des deux batteries Afin d'éviter les blessures pendant l'entretien du système hybride de 36 V, débrancher  les deux batteries. Voir schéma.	
Printed in U.S.A.		WLC	15804643	

Vehicle Identification (cont.)

Under the hood is:

- A hybrid badge attached to the 12 volt battery cover
- A label showing the battery locations (attached to the radiator core support)

Vehicle Identification (cont.)

A battery cover with an imprint of a GM hybrid logo sits directly behind the rear passenger seats.

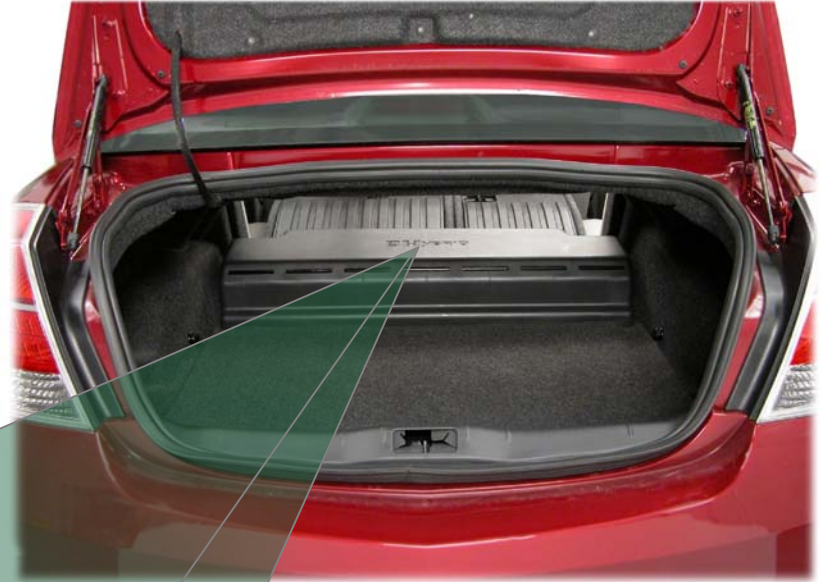

DC/AC Voltage Classifications

Electricity is categorized as either low, intermediate, or high voltage.

- Low voltage – from 0 to 30 volts DC / 0 to 15 volts AC
- Intermediate voltage – from 30 volts or greater to 60 volts DC / 15 volts or greater to 30 volts AC
- High voltage – any voltage greater than 60 volts DC / 30 volts AC

Color coding is used to identify the different levels of voltage – blue for intermediate and orange for high.

The Saturn AURA Green Line and Chevrolet Malibu hybrids fall within the intermediate range.

Two-mode hybrids and GM's Silverado and Sierra Parallel Hybrid Trucks are a combination of intermediate and high voltage systems (see chart footnote).

Classification	Low Voltage	Intermediate Voltage	High Voltage
Voltage Ranges	DC \leq 30v — AC \leq 15v	DC $>$ 30 \leq 60v — AC $>$ 15 \leq 30v ^{RMS}	DC $>$ 60v — AC $>$ 30v ^{RMS}
Vehicle Application	Conventional	Saturn VUE and AURA Green Line Hybrids Chevrolet Malibu Hybrid * GMC Sierra/Chevrolet Silverado Parallel Hybrid Trucks	Two-mode Hybrid ** GMC Sierra/Chevrolet Silverado Parallel Hybrid Trucks
<p>* <i>Applicable to 36v DC Hybrid Battery Pack, 36v DC Power Steering System and 36v DC Starter Generator Control Module (input)</i></p> <p>** <i>Applicable to Starter Generator Control Module (inverted APO output) and 120v AC Accessory Power Outlets (APO)</i></p>			

Note: Presently there are no industry standards to identify intermediate voltage. GM has chosen BLUE for the cable color.

DC Voltage Classifications (cont.)

Even though the Saturn AURA Green Line and the Chevrolet Malibu Hybrid uses lower voltage than other hybrids you may encounter, they must still be approached with caution.



Key Hybrid Components

This illustration shows the location of the hybrid components.

Note: Chevrolet Malibu Hybrid shown, Saturn AURA Green Line similar.

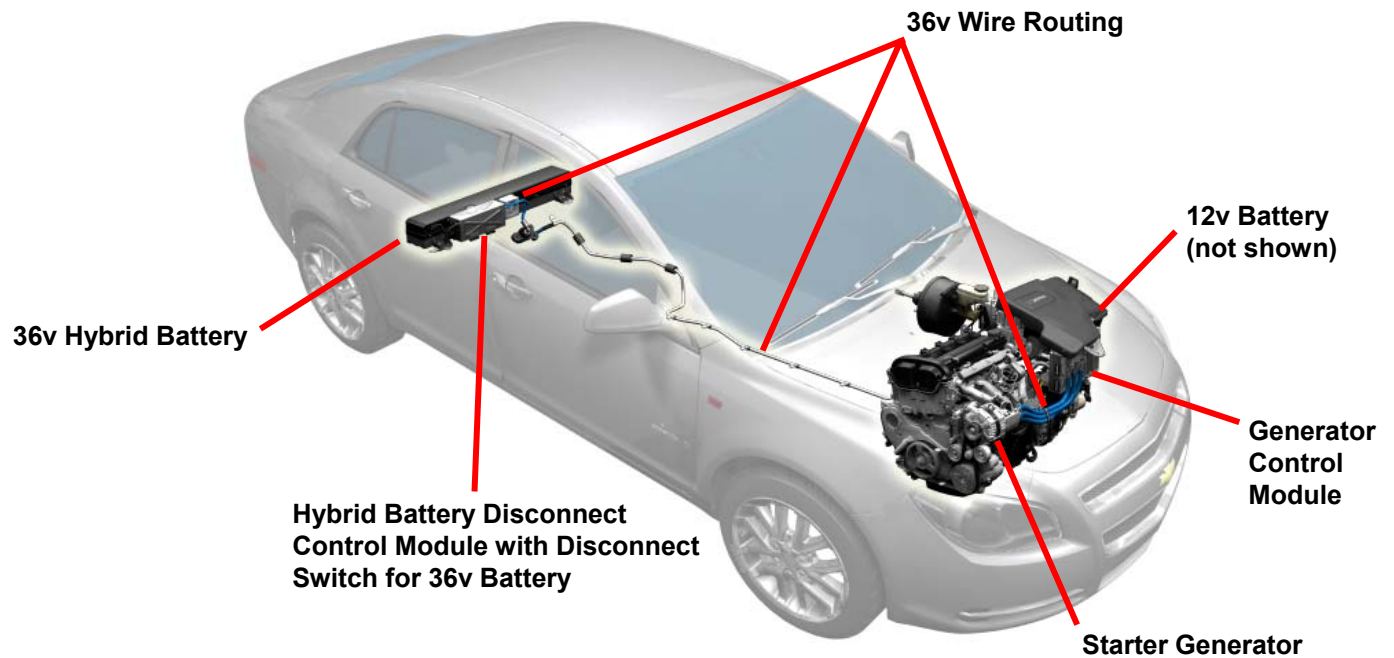

Key Hybrid Components (cont.)

The Saturn AURA Green Line and Chevrolet Malibu Hybrid use a conventional internal combustion engine coupled with a starter generator to efficiently power the vehicle.

Note that all intermediate voltage cables used on the hybrid model are covered in blue sheathing for easy identification. The exception is when the hybrid battery cable is routed beneath the vehicle in a rigid, metal conduit tubing.

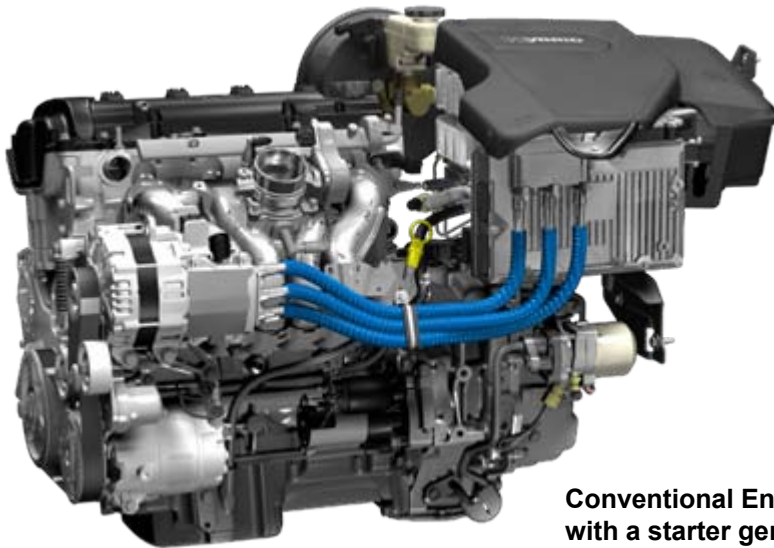

**Conventional Engine
with a starter generator**

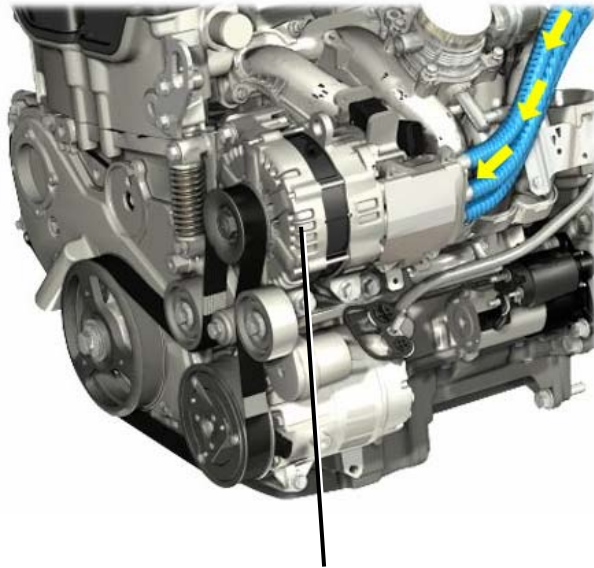

Starter generator

Key Hybrid Components (cont.)

A 3-phase starter generator, capable of generating more than 5000 Watts of electrical power, starts the engine when the vehicle is in the Auto Stop mode. The unit is mounted on the right side of the engine and replaces the standard generator used on non-hybrid models.

Intermediate voltage cables are routed through the back of the starter generator. The cables carry 36-42 volts of electricity.

Always use caution when you are near these cables until you are sure the hybrid electrical system is disabled!

Key Hybrid Components (cont.)

The generator control module, which is mounted on the left side of the engine, manages the routing of the 36 volt electrical system.

The generator control module receives the electrical current through two central terminal blocks that contain the 3-phase, 12 volt battery and 36 volt generator battery cables. These cables enter the blocks from the bottom and side. A protective plate covers the terminal blocks and cables.

Two coolant hoses, attached to the back of the module, connect the generator control module with the engine's cooling system. These hoses may contain hot coolant that could scald if they are disconnected or cut.

Note that blue wiring is used to indicate intermediate voltage.

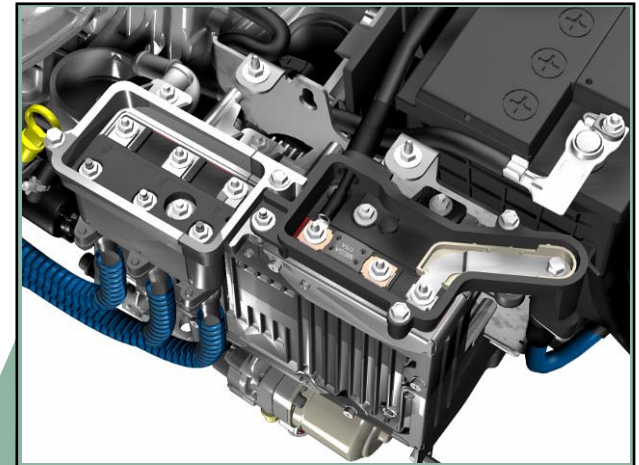

Cables from the starter generator, 12v battery and 36v battery enter the side and bottom of the generator control module (cover removed for clarity)

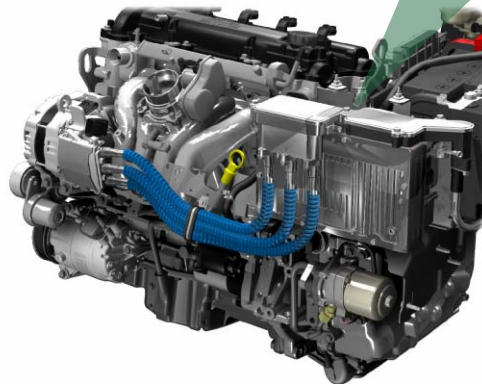

Key Hybrid Components (cont.)

A Nickel Metal Hydride (NiMH) 36 volt hybrid battery is mounted in the trunk compartment directly behind the rear passenger seats.



Battery cover removed for clarity

Key Hybrid Components (cont.)

A separate box, called the hybrid battery disconnect control module, is attached to the hybrid battery case.

Within the box are the negative and positive battery cables for the hybrid battery. Opening the hinged cover causes a spring-loaded disconnect switch to interrupt electrical flow from the hybrid battery and quickly discharge stored electrical energy in the generator control module.

A 10 mm hex head bolt secures the Hybrid Battery Disconnect Control Module



Hinges attached to the battery hold the cover in place

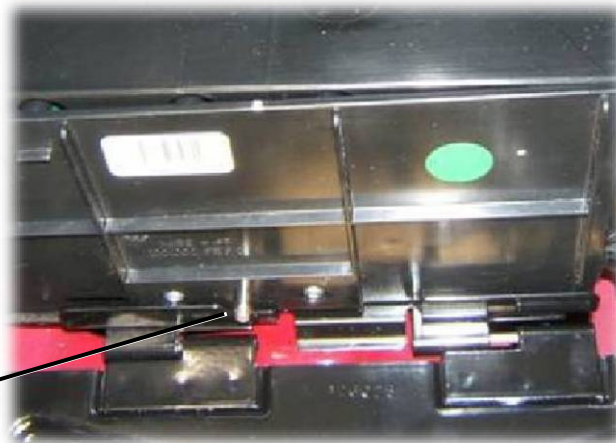

Disconnect Switch
(shown with Hybrid
Battery Disconnect
Control Module
cover open)

Key Hybrid Components (cont.)

A 12 volt battery provides power for the vehicle's accessories such as the radio, HVAC, and lighting. It is also used during the initial start-up of the vehicle.

Two negative (-) cables attach to the negative (-) battery terminal.

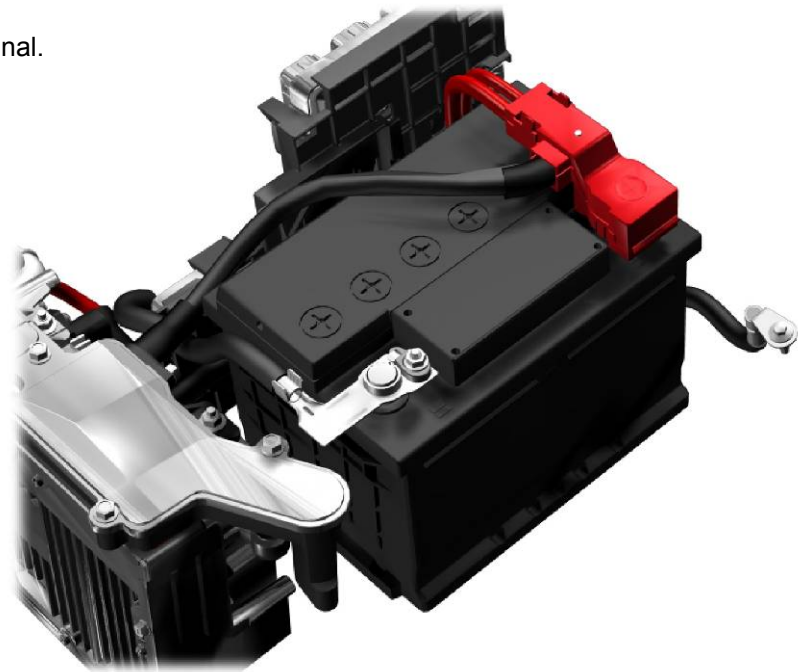

Key Hybrid Components (cont.)

A hood ajar switch is mounted near the hood latch and prevents Auto Stop from functioning if the hood of the vehicle is not fully latched.

If the hood is opened while the vehicle is in Auto Stop, the tachometer will move to the OFF position and the engine will be disabled from restarting unless the ignition key is used.

Note the hood ajar switch will not prevent current flow through the 36 volt electrical system.



Airbag Deployment*

A contactor inside the hybrid battery is designed to open upon rear impact detection or one or more air bags deploy. This will cause current flow in the 36 volt cable to be reduced to a low level.

After air bag deployment, wait at least 10 seconds to allow any undeployed air bag reserve energy to dissipate.

To ensure personal safety, it is essential to disable the 12 volt power if one or more air bags remains undeployed.



*For more information on air bags go to the Emergency Personnel Information link at www.gmstc.com

Disabling 12 Volt Power

Perform EACH of the following steps to disable the 12 volt electrical system. This includes power to the airbag system.

1. Turn the ignition key to the OFF position
OR if the ignition key is not accessible, remove the run/crank relay located in the underhood fuse block
2. Disconnect or cut BOTH 12v negative (-) battery cables
3. Verify tachometer needle is pointing to OFF

WAIT a minimum of **10 seconds** to allow any undeployed airbag reserve energy to dissipate.



Run/Crank Relay

Cut here to disable BOTH 12v negative cables at once



WARNING: WAIT a minimum of 10 seconds to allow the undeployed airbag reserve energy to dissipate.



36 Volt Electrical System

Do NOT cut the intermediate voltage (36v) cable, because there is a higher arc potential.

First perform the “Disabling 12 Volt Power” procedure on the previous page to eliminate current flow on the 12 volt electrical system. This also reduces the 36 volt current flow to a low level in the intermediate voltage (36v) cable. No further action is required.

CAUTION: Cutting the intermediate voltage cable may result in an arc hazard.

Note: The intermediate voltage cable routed under vehicle is not colored blue but is housed in a metal conduit



CAUTION: Cutting the intermediate voltage cable may result in an arc hazard.

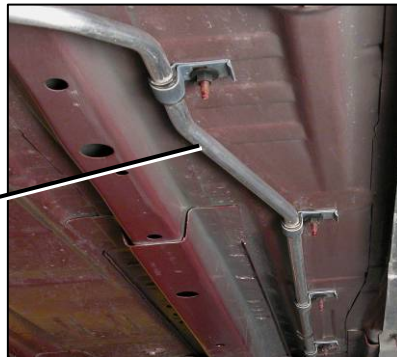

Cut Zones

CAUTION: DO NOT cut the vehicle until all of the electrical systems have been deactivated and isolated. Cutting into the vehicle prior to disconnecting and isolating the electrical energy sources may cause an electrical arc and/or personal injury.

Do not cut the:

- Center of the vehicle. Intermediate 36 volt wiring is routed in a conduit tube beneath the vehicle.
- Roof rails between the windshield pillars and 'sail' panels.
- Hybrid battery. The hybrid battery has 36 volt electrical potential at all times.

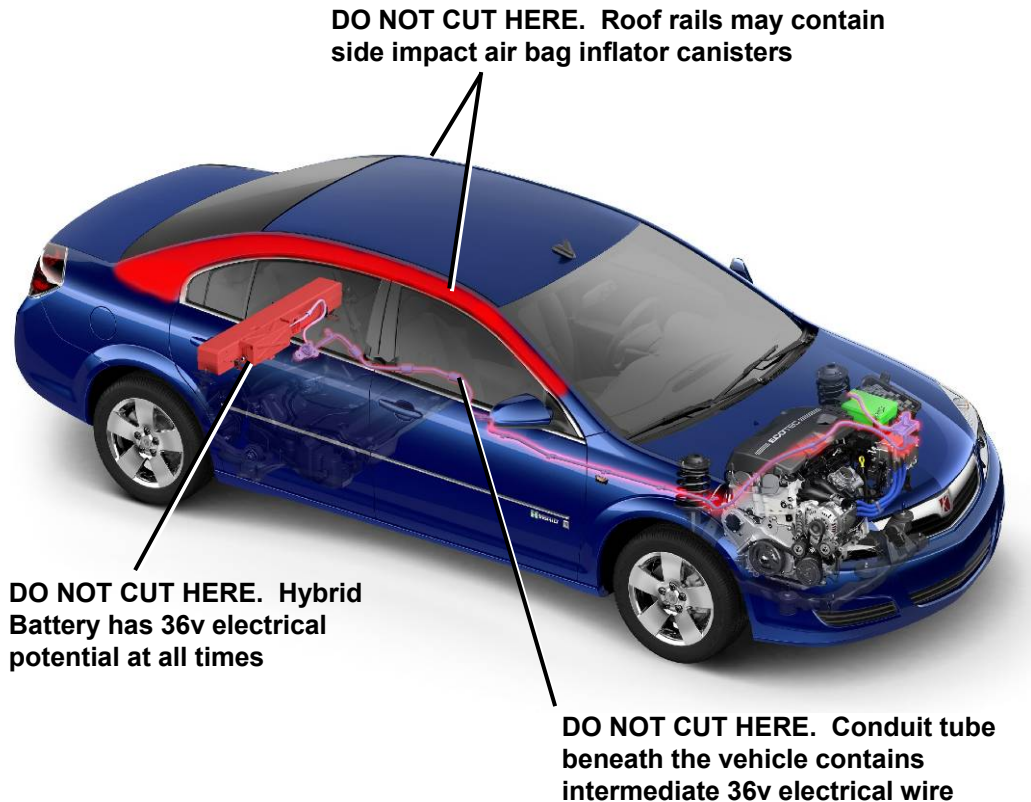

Highlighted areas indicate
DO NOT CUT Zones



Conclusion

As a first responder, it is essential that you manage the risks associated with an emergency event.

Responding to a situation involving a hybrid vehicle requires additional forethought and planning.

We are confident this guide will contribute positively toward attaining that goal.